

SUZUKI

GSF650/S

SERVICE MANUAL



FOREWORD

This manual contains an introductory description on the SUZUKI GSF650/S and procedures for its inspection/service and overhaul of its main components.

Other information considered as generally known is not included.

Read the GENERAL INFORMATION section to familiarize yourself with the motorcycle and its maintenance. Use this section as well as other sections to use as a guide for proper inspection and service. This manual will help you know the motorcycle better so that you can assure your customers of fast and reliable service.

* This manual has been prepared on the basis of the latest specifications at the time of publication. If modifications have been made since then, differences may exist between the content of this manual and the actual motorcycle.

* Illustrations in this manual are used to show the basic principles of operation and work procedures. They may not represent the actual motorcycle exactly in detail.

* This manual is written for persons who have enough knowledge, skills and tools, including special tools, for servicing SUZUKI motorcycles. If you do not have the proper knowledge and tools, ask your authorized SUZUKI motorcycle dealer to help you.

▲ WARNING

Inexperienced mechanics or mechanics without the proper tools and equipment may not be able to properly perform the services described in this manual. Improper repair may result in injury to the mechanic and may render the motorcycle unsafe for the rider and passenger.

GROUP INDEX

GENERAL INFORMATION

1

PERIODIC MAINTENANCE

2

ENGINE

3

FUEL SYSTEM

4

CHASSIS

5

ELECTRICAL SYSTEM

6

SERVICING INFORMATION

7

SUZUKI MOTOR CORPORATION

HOW TO USE THIS MANUAL

TO LOCATE WHAT YOU ARE LOOKING FOR:

1. The text of this manual is divided into sections.
2. The section titles are listed in the GROUP INDEX.
3. Holding the manual as shown at the right will allow you to find the first page of the section easily.
4. The contents are listed on the first page of each section to help find the item and page you need.

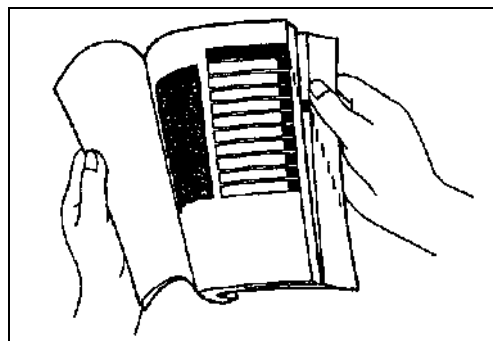

COMPONENT PARTS AND WORK TO BE DONE

Under the name of each system or unit, is its exploded view. Work instructions and other service information such as the tightening torque, lubricating points and locking agent points, are provided.

Example: Front wheel





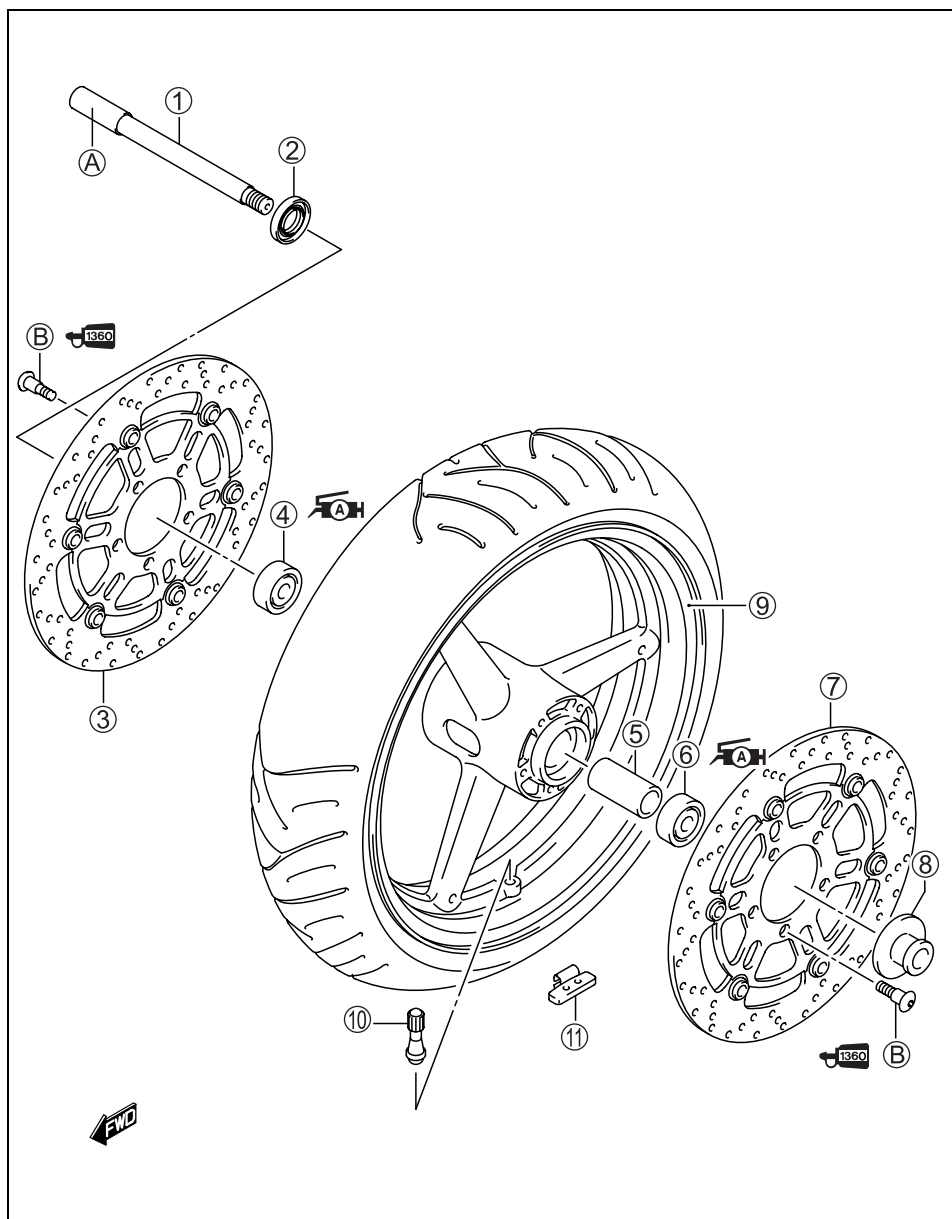

















①	Front axle
②	Dust seal
③	Brake disc (RH)
④	Bearing (RH)
⑤	Spacer
⑥	Bearing (LH)
⑦	Brake disc (LH)
⑧	Collar
⑨	Front wheel
⑩	Air bleeder valve
⑪	Balancer
A	Front axle
B	Brake disc bolt

ITEM	N·m	kgf·m
A	65	6.5
B	23	2.3



SYMBOL

Listed in the table below are the symbols indicating instructions and other information necessary for servicing. The meaning of each symbol is also included in the table.

SYMBOL	DEFINITION	SYMBOL	DEFINITION
	Torque control required. Data beside it indicates specified torque.		Apply THREAD LOCK "1342". 99000-32050
	Apply oil. Use engine oil unless otherwise specified.		Apply THREAD LOCK SUPER "1360". 99000-32130
	Apply molybdenum oil solution (mixture of engine oil and SUZUKI MOLY PASTE in a ratio of 1:1).		Use fork oil. 99000-99044-10G
	Apply SUZUKI SUPER GREASE "A". 99000-25010		Apply or use brake fluid.
	Apply SUZUKI MOLY PASTE. 99000-25140		Measure in voltage range.
	Apply SUZUKI SILICONE GREASE. 99000-25100		Measure in resistance range.
	Apply PBC GREASE. 99000-25110		Measure in current range.
	Apply THERMO-GREASE. 99000-59029		Measure in diode test range.
	Apply SUZUKI BOND "1207B". 99000-31140		Measure in continuity test range.
	Apply SUZUKI BOND "1215". 99000-31110		Use special tool.
	Apply THREAD LOCK SUPER "1303". 99000-32030		Indication of service data.
	Apply THREAD LOCK SUPER "1322". 99000-32110		

GENERAL INFORMATION

1

CONTENTS

WARNING/CAUTION/NOTE	1- 2
GENERAL PRECAUTIONS	1- 2
SUZUKI GSF650 (2005-MODEL)	1- 4
SUZUKI GSF650S (2005-MODEL)	1- 4
SERIAL NUMBER LOCATION	1- 4
FUEL AND OIL RECOMMENDATION	1- 5
FUEL (For Canada)	1- 5
FUEL (For other countries)	1- 5
ENGINE OIL	1- 5
BRAKE FLUID	1- 5
FRONT FORK OIL	1- 5
BREAK-IN PROCEDURES	1- 6
CYLINDER IDENTIFICATION	1- 6
INFORMATION LABELS	1- 7
SPECIFICATIONS	1- 8

COUNTRY AND AREA CODES

The following codes stand for the applicable country(-ies) and area(-s).

CODE	COUNTRY OR AREA
E-02	England (UK)
E-19	European markets
E-28	Canada

WARNING/CAUTION/NOTE

Please read this manual and follow its instructions carefully. To emphasize special information, the symbol and the words WARNING, CAUTION and NOTE have special meanings. Pay special attention to the messages highlighted by these signal words.

⚠ WARNING

Indicates a potential hazard that could result in death or injury.

CAUTION

Indicates a potential hazard that could result in motorcycle damage.

NOTE:

Indicates special information to make maintenance easier or instructions clearer.

Please note, however, that the warnings and cautions contained in this manual cannot possibly cover all potential hazards relating to the servicing, or lack of servicing, of the motorcycle. In addition to the WARNINGS and CAUTIONS stated, you must use good judgement and basic mechanical safety principles. If you are unsure about how to perform a particular service operation, ask a more experienced mechanic for advice.

GENERAL PRECAUTIONS

⚠ WARNING

- * **Proper service and repair procedures are important for the safety of the service mechanic and the safety and reliability of the motorcycle.**
- * **When 2 or more persons work together, pay attention to the safety of each other.**
- * **When it is necessary to run the engine indoors, make sure that exhaust gas is forced outdoors.**
- * **When working with toxic or flammable materials, make sure that the area you work in is well-ventilated and that you follow all of the material manufacturer's instructions.**
- * **Never use gasoline as a cleaning solvent.**
- * **To avoid getting burned, do not touch the engine, engine oil, oil cooler and exhaust system until they have cooled.**
- * **After servicing the fuel, oil, exhaust or brake systems, check all lines and fittings related to the system for leaks.**

CAUTION

- * If parts replacement is necessary, replace the parts with Suzuki Genuine Parts or their equivalent.
 - * When removing parts that are to be reused, keep them arranged in an orderly manner so that they may be reinstalled in the proper order and orientation.
 - * Be sure to use special tools when instructed.
 - * Make sure that all parts used in reassembly are clean. Lubricate them when specified.
 - * Use the specified lubricant, bond or sealant.
 - * When removing the battery, disconnect the negative cable first and then the positive cable. When reconnecting the battery, connect the positive cable first and then the negative cable, and replace the terminal cover on the positive terminal.
 - * When performing service to electrical parts, if the service procedures not require use of battery power, disconnect the negative cable the battery.
 - * When tightening the cylinder head and case bolts and nuts, tighten the larger sizes first. Always tighten the bolts and nuts diagonally from the inside working out and to the specified tightening torque.
 - * Whenever you remove oil seals, gaskets, packing, O-rings, locking washers, self-locking nuts, cotter pins, circlips and certain other parts as specified, be sure to replace them with new ones. Also, before installing these new parts, be sure to remove any left over material from the mating surfaces.
 - * Never reuse a circlip. When installing a new circlip, take care not to expand the end gap larger than required to slip the circlip over the shaft. After installing a circlip, always ensure that it is completely seated in its groove and securely fitted.
 - * Use a torque wrench to tighten fasteners to the specified torque. Wipe off grease and oil if a thread is smeared with them.
 - * After reassembling, check parts for tightness and proper operation.
-
- * To protect the environment, do not unlawfully dispose of used motor oil, engine coolant and other fluids: batteries and tires.
 - * To protect Earth's natural resources, properly dispose of used motorcycle and parts.

SUZUKI GSF650 (2005-MODEL)



* Difference between photographs and actual motorcycles may exist depending on the markets.

SUZUKI GSF650S (2005-MODEL)



* Difference between photographs and actual motorcycles may exist depending on the markets.

SERIAL NUMBER LOCATION

The frame serial number or V.I.N. (Vehicle Identification Number) ① is stamped on the right side of the steering head pipe and frame down tube. The engine serial number ② is located on the right side of the crankcase. These numbers are required especially for registering the machine and ordering spare parts.

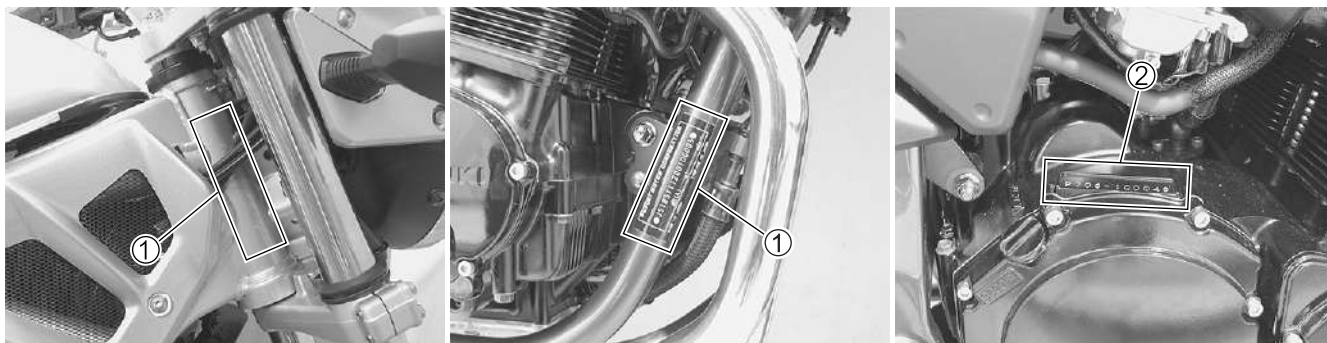

FUEL AND OIL RECOMMENDATION

FUEL (For Canada)

Use only unleaded gasoline of at least 87 pump octane (R/2 + M/2) or 91 octane or higher rated by the research method.

Gasoline containing MTBE (Methyl Tertiary Butyl Ether), less than 10% ethanol, or less than 5% methanol with appropriate cosolvents and corrosion inhibitor is permissible.

FUEL (For other countries)

Gasoline used should be graded 91 octane (Research Method) or higher. An unleaded gasoline is recommended.

ENGINE OIL

Oil quality is a major contributor to your engine's performance and life. Always select good quality engine oil. Use SF/SG or SH/SJ with JASO MA in API (American Petroleum Institute) classification.

Suzuki recommends the use of SAE 10W-40 engine oil. If SAE 10W-40 engine oil is not available, select an alternative according to the following chart.

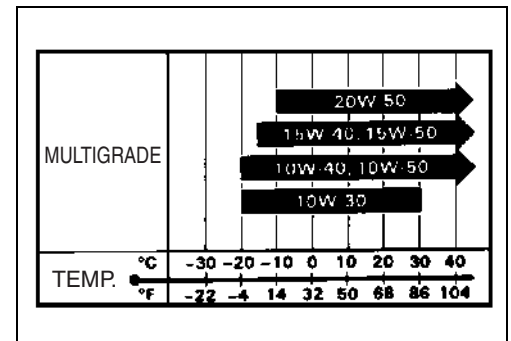

BRAKE FLUID

Specification and classification: DOT 4

▲ WARNING

Since the brake system of this motorcycle is filled with a glycol-based brake fluid by the manufacturer, do not use or mix different types of fluid such as silicone-based and petroleum-based fluid for refilling the system, otherwise serious damage will result.

Do not use any brake fluid taken from old or used or unsealed containers.

Never re-use brake fluid left over from a previous servicing, which has been stored for a long period.

FRONT FORK OIL

Use fork oil #10 or equivalent fork oil.